

SONY



VPL-E300 Series

Data Projectors

VPL-EW348 VPL-EW345 VPL-EW315
VPL-EX345 VPL-EX315 VPL-EX340 VPL-EX310



BrightEra™

HDMI

4DDBT™



Present Clear, Bright Images in Larger Rooms; Plus Flexible Connectivity and Low Running Costs – Great Performance for Any Environment

VPL-E300 Series projectors are ideal for mid-sized and larger classrooms and meeting rooms.

Quiet, compact and powerful, they deliver bright, high-quality images with a maximum of 4,200-lumens color light output that can be seen clearly even in bright rooms, with Sony's 3LCD technology assuring natural, vivid colors. These projectors are an ideal partner for today's integrated AV/IT environments, expanding your connectivity options with HDBaseT™, dual HDMI ports, and Direct USB Display connection. A convenient input label function makes life simpler, confirming on screen the name of connected devices.

Add VPL-E300 Series projectors to your network and simultaneously view presentations from up to four connected PCs. Slip in an optional Wi-Fi dongle and present directly and wirelessly from laptops, smartphones, and tablets. Control the projector remotely with a free app for smartphones and tablets. You don't even need to bring a PC to meetings—just slip in a USB thumb drive and start presenting.

A range of energy-saving features and a long-lasting lamp contribute to low ownership costs, and maintenance is simplified by a rear lamp access feature.

*HDBaseT™ and the HDBaseT Alliance logo are trademarks of the HDBaseT Alliance.

High Image Quality

3LCD BrightEra™ Natural and Vivid Color Images

Thanks to an optical system that constantly projects three basic colors, this projector offers excellent light efficiency which ensures colorful and bright images. Sony's BrightEra™ panels deliver improved panel light resistance, higher resolution, high brightness, and increased panel reliability. High color reproducibility is important especially when using colorful content, such as materials typically used in classrooms.

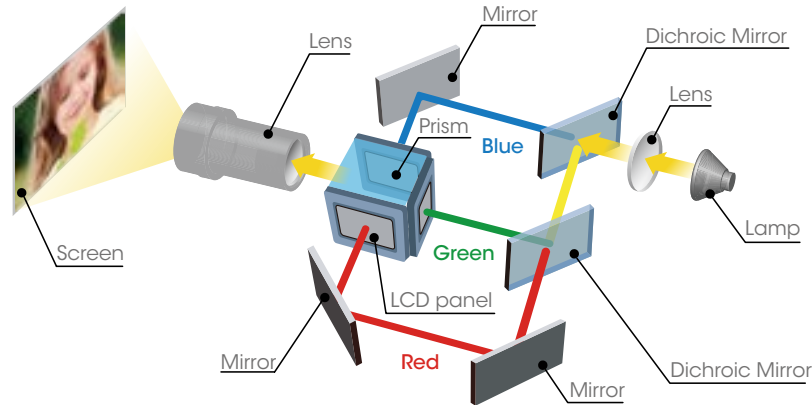

3LCD Projection System

High Brightness: 4,200-lumens Color Light Output

With very high brightness of up to 4,200-lumens color light output, projectors in the VPL-E300 Series give a clearer image in high ambient light, making them very suitable for larger venues.

Various Picture Modes for Optimal Picture Quality

VPL-E300 Series projectors have six available picture modes for correct picture quality: Dynamic, Standard, Presentation, Blackboard, Whiteboard, and Cinema. With the choice of six picture modes and three brightness modes, you can select the most suitable picture/brightness combination according to the picture source and environment, to create the optimal image.

Dynamic



Optimized for presenting in a bright environment, with bright and colorful text, graphics, and images.

Standard



This is ideal to deliver a presentation under fluorescent lighting in offices and classrooms.

Presentation



This setting delivers the greatest light output, ideal in a bright environment, both inside and outside.

Blackboard/Whiteboard



Optimized to deliver clear images on a blackboard/whiteboard in the classroom, supporting teaching where there is no projection screen.

Ease of Use

Simple Installation with HDBaseT

HDBaseT is a multi-signal transmission system via a single cable, which simplifies the installation task. It cuts total system cost by reducing not just cabling requirements but also the number of required signal extenders and receiver boxes.

One Cat5e/6 cable can run up to 100 meters, reducing the number of cable runs and eliminating the need for signal extenders. And fewer signal extenders and receiver boxes mean fewer potential points of failure. In addition, Cat5e/6 cables are much easier to terminate than cables such as HDMI, and therefore can be simply and quickly terminated even onsite during the installation process.

*For VPL-EW348

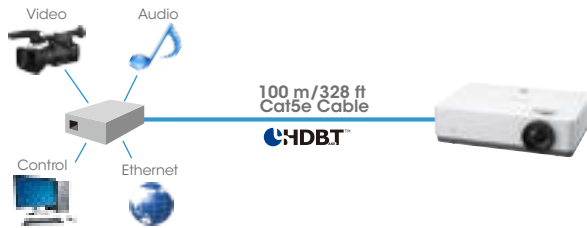

Dual HDMI Input Terminal

Thanks to dual HDMI input terminals, you can use both standard signal sources (PC/Video) and the latest wireless input adapters without switching connections.

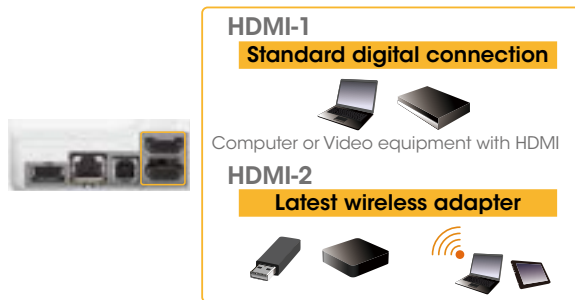

*HDMI cable is not supplied

Simulated image

Network Presentation (LAN)

When the projector is installed in a LAN, presentations can be projected from any PC and Mac on the network. A tablet or smartphone can be connected at the same time. You can project jpg, pdf, and other supported formats. Up to four users can project PC/Mac images simultaneously, while up to eight*¹ users can connect to one projector.

Wireless Presentation Software

For MS Windows/Mac OS: Projector Station for Network Presentation

For iOS/Android OS: VueMagic*²

*¹ Up to seven users for wireless.

*² The application for tablets and smartphones is provided by Pixelworks.

For details, please visit the following website:
<http://PWPresenter.pixelworks.com>

Multiple Inputs

VPL-E300 Series projectors accept a wide variety of inputs signals, greatly expanding system connection possibilities.

Silent Design

With an advanced air discharge system, Sony's whisper-quiet fan emits less than 35 dB during operation (Lamp mode: High/Low: 35 dB/29 dB)

Slim, Attractive Blend-in Design

The slim, stylish case design features a flat top surface that blends in discreetly when the projector is ceiling mounted.

Rear Side Lamp Access for Easy Maintenance

The lamp change position has shifted to the back of the unit. This enables easy lamp access when the projector is hanging from a ceiling mount.



Input Label

You can customize the input label that appears in the input menu on screen. This gives you a clear understanding of which equipment is connected.



Simulated image

Network Presentation Portable Edition

The portable edition function allows you to install the Network Presentation application into a general-purpose USB mass storage device. This enables guest users to run the Network Presentation application via the USB device without having to install the app on their own laptop.

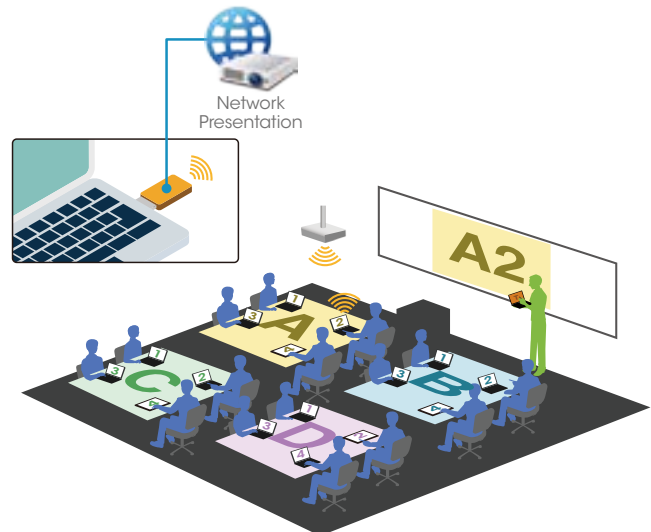

Simulated image

Use Case of "Network Presentation"

Three-way Wireless Connection

These projectors support three different methods of wireless connection, so you can achieve the system best suited to every situation

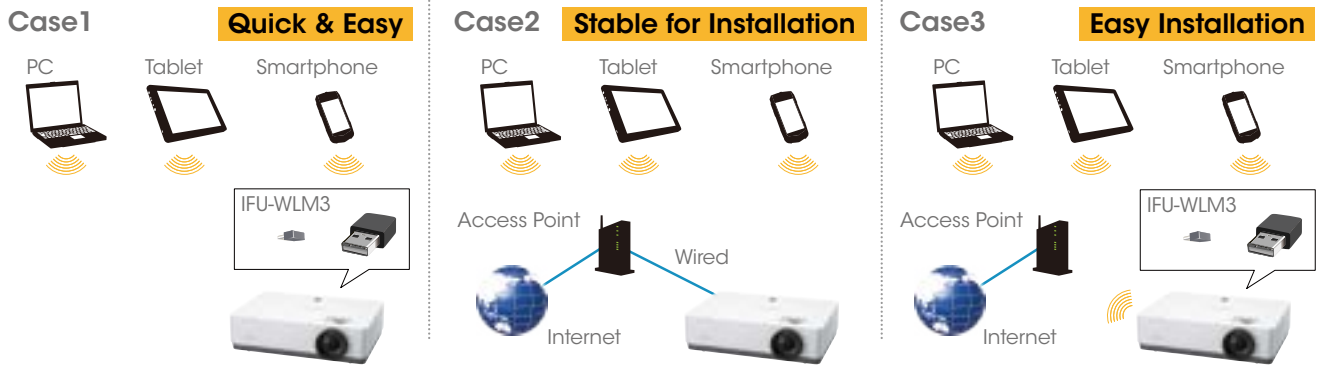

Good TCO, Energy-efficient Design

Long-lasting Lamp

The lamp driver optimally controls the wattage of the lamp and achieves a long-lasting lamp replacement time of 10,000 hours with lamp brightness set to low. This extends the lamp replacement time by more than 43% compared with the previous model.

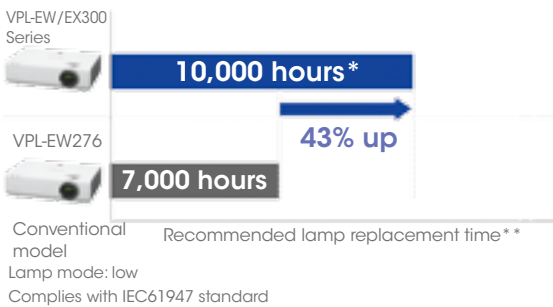

*Usage condition example : 8 hours per day x 5 times per week x 5 years
**The figures are the expected maintenance time and not guaranteed. They will depend on the environment or how the projector is used

Auto Power Saving Function

• Auto Mode (Auto Brightness Adjustment Function)

The brightness of the lamp's output is automatically adjusted depending on the brightness of the projected image, to avoid unnecessary power consumption. When showing darker images that don't require high brightness, lamp output decreases.

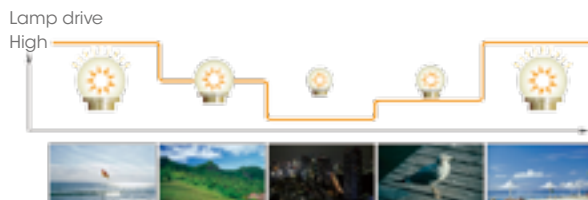

• Blank

The VPL-E300 Series projectors can temporarily disable video signal output. This function can be easily operated with just the touch of a button on the supplied Remote Commander™ unit. In addition, this function allows blank image projection with low power consumption using lamp control technology.

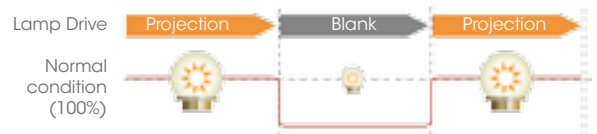

• Lamp Dimming Function

The VPL-E300 Series projectors are equipped with a lamp dimming function. After 10 seconds of a static signal feed, the lamp dims by approximately 15% which is hardly noticeable. If one of these projectors is left powered on while not in use, after a set period of time it will automatically detect no change of signal input and will dim the lamp to as low as approximately 30% of original brightness to significantly reduce energy consumption.

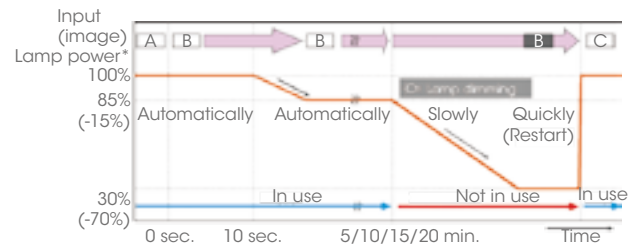

ECO MODE Key

With a single push of the ECO MODE key on either the projector or the supplied Remote Commander unit, users can select an energy-saving setting from the ECO Mode menu.

CONNECTOR PANELS

VPL-EW348

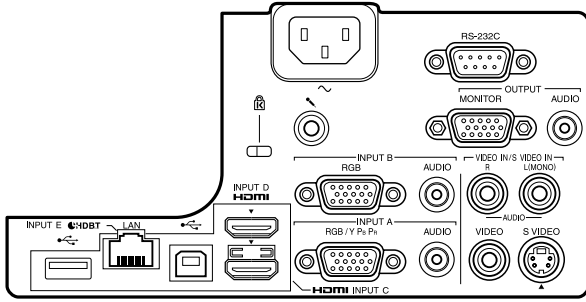

VPL-EW345 / EW315 / EX345 / EX315

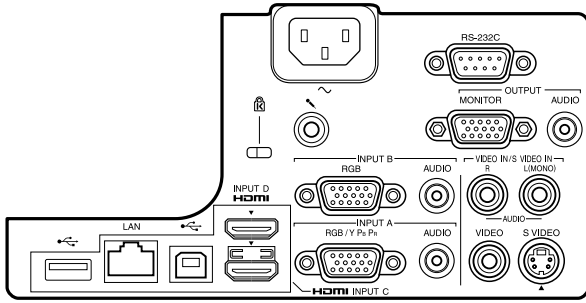

VPL-EX340 / EX310

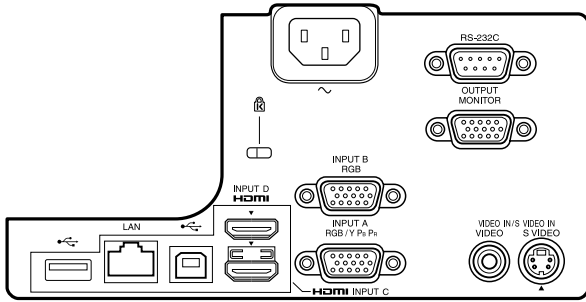

OPTIONAL ACCESSORIES



LMP-E221
Projector Lamp (for replacement)



IFU-WLM3
USB wireless LAN module

DIMENSIONS

Unit: mm (inches)

Front

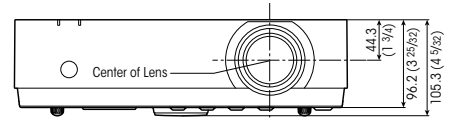

Top

VPL-EW348 / EW345 / EW315

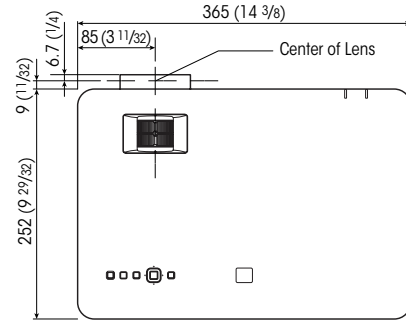

VPL-EX345 / EX340 / EX315 / EX310

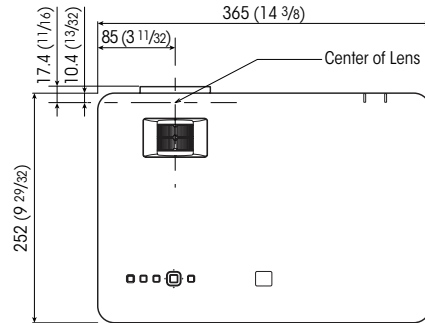

Bottom

VPL-EW348 / EW345 / EW315

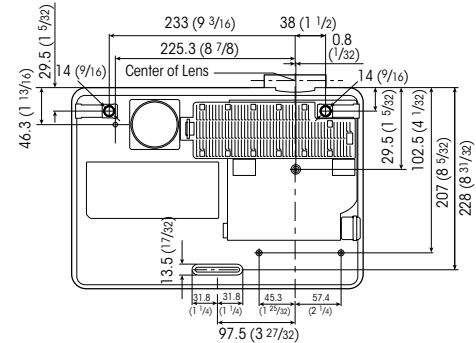

VPL-EX345 / EX340 / EX315 / EX310

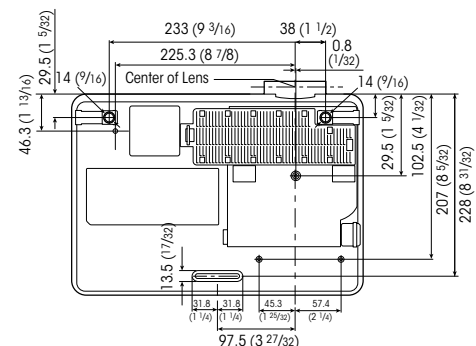

SPECIFICATIONS

		VPL-EW348	VPL-EW345	VPL-EW315	VPL-EX345	VPL-EX315	VPL-EX340	VPL-EX310
Display system		3 LCD system						
Display device	Size of effective display area	0.75" (19 mm) x 3 BrightEra LCD Panel Aspect ratio 16:10			0.63" (16 mm) x 3 BrightEra LCD Panel Aspect ratio: 4:3			
	Number of pixels	3,072,000 (1280x800 x 3) pixels			2,359,296 (1024x768 x 3) pixels			
Projection lens	Zoom	Manual (Approx. x 1.6)						
	Focus	Manual						
	Throw ratio	1.10:1 to 1.79:1			1.40:1 to 2.27:1			
Light source		High pressure mercury lamp 225 W type						
Recommended lamp replacement time*1		4000H / 6000H / 10000H (Lamp mode: High / Standard / Low)						
Filter cleaning cycle*1		Max. 10,000 H						
Screen size		30" to 300" (0.76 m to 7.62 m) (measured diagonally)						
Light output (Lamp mode: High / Standard*2 / Low*2)		4200 lm / 3200 lm / 2500 lm	3800 lm / 3000 lm / 2500 lm	4200 lm / 3200 lm / 2500 lm	3800 lm / 3000 lm / 2500 lm	4200 lm / 3200 lm / 2500 lm	3800 lm / 3000 lm / 2500 lm	3800 lm / 3000 lm / 2500 lm
	Color light output (Lamp mode: High / Standard*2 / Low*2)	4200 lm / 3200 lm / 2500 lm	3800 lm / 3000 lm / 2500 lm	4200 lm / 3200 lm / 2500 lm	3800 lm / 3000 lm / 2500 lm	4200 lm / 3200 lm / 2500 lm	3800 lm / 3000 lm / 2500 lm	3800 lm / 3000 lm / 2500 lm
Contrast ratio (full white / full black)*3		3700:1			3300:1			
Displayable scanning frequency	Horizontal	15 kHz to 92 kHz						
	Vertical	48 Hz to 92 Hz						
Display resolution	Computer signal input	Maximum display resolution: UXGA 1600 x 1200 dots*4						
	Video signal input	NTSC, PAL, SECAM, 480/60i, 576/50i, 480/60p, 576/50p, 720/60p, 720/50p, 1080/60i, 1080/50i, 1080/60p*5, 1080/50p*5						
Color system		NTSC3.58, PAL, SECAM, NTSC4.43, PAL-M, PAL-N, PAL-60						
Keystone correction (Max.)		Vertical: +/-20 degrees				Vertical: +/-30 degrees		
OSD language		27-language (English, French, German, Italian, Spanish, Portuguese, Japanese, Simplified Chinese, Traditional Chinese, Korean, Russian, Dutch, Norwegian, Swedish, Thai, Arabic, Turkish, Polish, Vietnamese, Farsi, Finnish, Indonesian, Hungary, Greek, Czech, Slovakia, Romania)						
Computer and video signal input/output	INPUT A	RGB / Y Pb Pr input connector: Mini D-sub 15-pin (female) Audio input connector: Stereo mini jack				RGB / Y Pb Pr input connector: Mini D-sub 15-pin (female)		
	INPUT B	RGB input connector: Mini D-sub 15-pin (female) Audio input connector: Stereo mini jack				RGB input connector: Mini D-sub 15-pin (female)		
	INPUT C	HDMI input connector: HDMI 19-pin, HDCP support						
	INPUT D	HDMI input connector: HDMI 19-pin, HDCP support						
	INPUT E	HDBaseT						
	S VIDEO IN	S Video input connector: Mini DIN 4-pin						
	VIDEO IN	Video input connector: Pin jack						
	OUTPUT	Monitor output connector*6: Mini D-sub 15-pin (female) Audio output connector*7: Stereo mini jack (variable out)				Monitor output connector*6: Mini D-sub 15-pin (female)		
Control signal input/output, Others		RS-232C connector: D-sub 9-pin (male) LAN connector: RJ-45, 10BASE-T/100BASE-TX USB: Type-A, Type-B Microphone input: Mini jack				RS-232C connector: D-sub 9-pin (male) LAN connector: RJ-45, 10BASE-T/100BASE-TX USB: Type-A, Type-B		
Speaker		16 W x 1 (monaural)						
Operating temperature (Operating humidity)		0°C to 40°C (32°F to 104°F) / 20% to 80% (no condensation)						
Storage temperature (Storage humidity)		-10°C to +60°C (-4°F to +140°F) / 20% to 80% (no condensation)						
Power requirements		AC 100 V to 240 V, 3.5 A to 1.5 A, 50 Hz / 60 Hz	AC 100 V to 240 V, 3.4 A to 1.5 A, 50 Hz / 60 Hz	AC 100 V to 240 V, 3.1 A to 1.4 A, 50 Hz / 60 Hz	AC 100 V to 240 V, 3.4 A to 1.5 A, 50 Hz / 60 Hz	AC 100 V to 240 V, 3.2 A to 1.4 A, 50 Hz / 60 Hz	AC 100 V to 240 V, 3.1 A to 1.4 A, 50 Hz / 60 Hz	AC 100 V to 240 V, 2.9 A to 1.3 A, 50 Hz / 60 Hz
Power consumption (Lamp mode: High / Standard*2 / Low*2)	AC 100 V to 120 V	341 W / 277 W / 240 W	334 W / 271 W / 233 W	310 W / 259 W / 230 W	336 W / 270 W / 233 W	314 W / 261 W / 233 W	305 W / 239 W / 202 W	284 W / 231 W / 203 W
	AC 220 V to 240 V	329 W / 269 W / 234 W	322 W / 263 W / 227 W	300 W / 252 W / 226 W	324 W / 262 W / 227 W	304 W / 254 W / 227 W	295 W / 233 W / 198 W	275 W / 225 W / 198 W
Power Consumption (Standby Mode)	AC 100 V to 120 V	0.5 W (when "Standby mode" is set to "Low")						
	AC 220 V to 240 V	0.5 W (when "Standby mode" is set to "Low")						
Power Consumption (Networked Standby Mode)	AC 100 V to 120 V	VPL-EW348: 18.5 W (LAN) / 14.0 W (optional WLAN module) / 19.4 W (ALL Terminals and Networks Connected, when "Standby Mode" is set to "Standard") VPL-EW345/EW315/EX345/EX315/EX340/EX310: 5.3 W (LAN) / 5.7 W (optional WLAN module) / 6.0 W (ALL Terminals and Networks Connected, when "Standby Mode" is set to "Standard")						
	AC 220 V to 240 V	VPL-EW348: 25.3 W (LAN) / 18.5 W (optional WLAN module) / 26.3 W (ALL Terminals and Networks Connected, when "Standby Mode" is set to "Standard") VPL-EW345/EW315/EX345/EX315/EX340/EX310: 5.5 W (LAN) / 6.0 W (optional WLAN module) / 6.3 W (ALL Terminals and Networks Connected, when "Standby Mode" is set to "Standard")						
Heat dissipation	AC 100 V to 120 V	1163 BTU/h	1139 BTU/h	1058 BTU/h	1146 BTU/h	1071 BTU/h	1041 BTU/h	969 BTU/h
	AC 220 V to 240 V	1122 BTU/h	1099 BTU/h	1023 BTU/h	1105 BTU/h	1037 BTU/h	1006 BTU/h	938 BTU/h
Outside dimensions		W 365 x H 96.2 x D 252 mm (W 14 3/8 x H 3 25/32 x D 9 29/32 inches) (without protrusions)						
Mass		4.1 kg / 9 lb				3.9 kg / 8 lb		
Supplied accessories		RM-PJ8 Remote Commander (1), Lithium battery: CR2025 (1), AC Power Cord (1), Operating Instructions (CD-ROM) (1), Quick Reference Manual (1), Mini D-sub 15-pin cable (1), Projector Station for Network Presentation application (CD-ROM) (1)						
Replacement lamp		LMP-E221						

*1 The figures are the expected maintenance time and not guaranteed. They will depend on the environment or how the projector is used.

*2 The values are estimate.

*3 This value is average.

*4 Available for the VESA Reduced Blanking signal.

*5 The following items are available for digital signal (HDMI input) only.

*6 Not available in standby. From INPUT A and INPUT B.

*7 Works as an audio switcher function. Output from a selected channel; not available in standby.

SONY

Distributed by

©2015 Sony Corporation. All rights reserved.

Reproduction in whole or in part without written permission is prohibited.

Features and specifications are subject to change without notice.

The values for mass and dimension are approximate.

"SONY", "BrightEra" and "Remote Commander" are trademarks of Sony Corporation.

Trademark PJLink is a trademark applied for trademark rights in Japan, the United States of America and other countries and areas.

The terms HDMI and HDMI High-Definition Multimedia Interface, and the HDMI Logo are trademarks or registered trademarks of HDMI Licensing LLC in the United States and other countries.

Pixelworks and VueMagic™ are trademark of Pixelworks Inc.

App Store is a service mark of Apple Inc.

HDBaseT™ and the HDBaseT Alliance logo are trademarks of the HDBaseT Alliance.

All other trademarks are the property of their respective owners.

MK20015V1YIT15SEP